



**REMET CNC**<sup>®</sup>  
TECHNOLOGY



**PRODUKT  
POLSKI**

 **MULCZERY LEŚNE**

 **FORESTRY MULCHERS**

 **FORSTMULCHER**

 **ЛЕСНЫЕ МУЛЬЧЕРЫ**



[www.remetcnc.com](http://www.remetcnc.com)  
[www.mulczery.pl](http://www.mulczery.pl)  
[www.rebaki24.pl](http://www.rebaki24.pl)



# KOSIARKI BIJAKOWE FMS

# FLAIL MOWERS



Model	HP min/max	mm	rpm	N°	N°	N°	kg	1 mm	2 mm	3 mm
<b>FMS-100</b>	15-50	1000	540	1x3 XPA	16	32	190	1120	780	760
<b>FMS-120</b>	15-50	1200	540	1x3 XPA	20	40	205	1320	780	760
<b>FMS-140</b>	20-50	1400	540	1x3 XPA	24	48	225	1520	780	760
<b>FMS-160</b>	20-50	1600	540	1x3 XPA	28	56	250	1730	780	760



 TYP BIJKA:  
MŁOTKOWY  
 TYPE OF HAMMER:  
HAMMER  
 SCHÄGELTYP:  
HAMMERSCHLEGEL  
 ТИП УДАРНИКА:  
МОЛОТОК



 TYP BIJKA:  
NÓZ TYPU Y  
 TYPE OF HAMMER:  
Y TYPE KNIFE  
 SCHÄGELTYP:  
Y-MESSER  
 ТИП УДАРНИКА:  
У-НОЖ

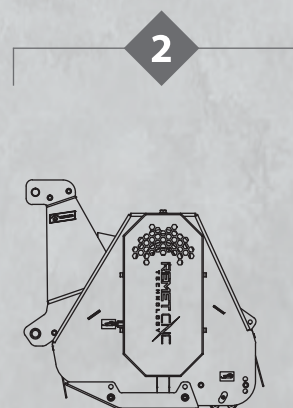
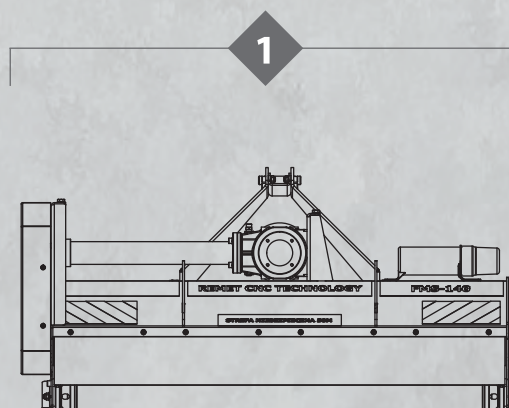







# FORESTRY

## MULCHERS F3

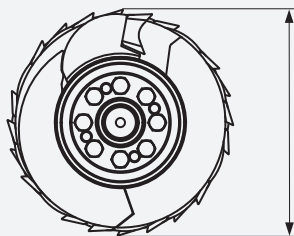
# MULCZERY

## LEŚNE F3







 ŚREDNICA ROTORA  
 ROTOR DIAMETER  
 ROTORDURCHMESSER  
 ДИАМЕТР РОТОРА  
**F3-150** 340 mm  
**F3-175** 340 mm  
**F3-200** 340 mm

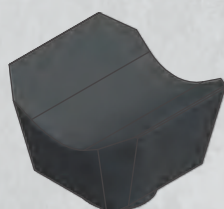

Model	HP min/max	mm	Ømm	rpm	N°	N°	kg	1	2	3
<b>F3-150</b>	50-120	1500	150	540	1x5 XPB	28	920	1755	1050	930
<b>F3-175</b>	50-120	1750	150	540	1x5 XPB	32	1000	2005	1050	930
<b>F3-200</b>	60-120	2000	150	540	1x5 XPB	38	1100	2255	1050	930



 TYP ZĘBA: DWUSTRONNY ZE STALI  
 O PODWYŻSZONEJ WYTRZYMAŁOŚCI  
 (HARTOWANY)  
 TOOTH TYPE: DOUBLE-SIDED STEEL  
 WITH INCREASED STRENGTH  
 (HARDENED)  
 ZAHNART- DOPPELSEITIG STAHL  
 MIT ERHÖHTER BESTÄNDIGKEIT  
 (GEHÄRTET)  
 ТИП ЗУБА - ДВУСТОРОННИЙ СТАЛЬ  
 С ПОВЫШЕННОЙ ПРОЧНОСТЬЮ  
 (ЗАКАЛЁННЫЙ)

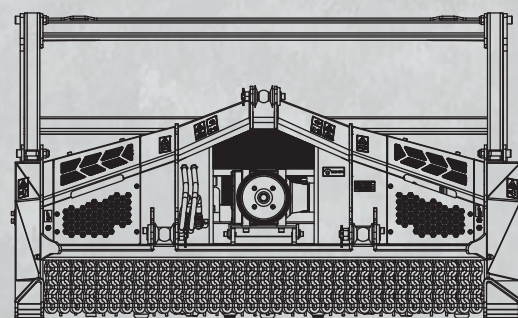

+48 690 917 917



Sklep internetowy: [www.rebaki24.pl](http://www.rebaki24.pl)



Producent: [www.remetcnc.com](http://www.remetcnc.com)







# MULCZERY

## LEŚNE F4

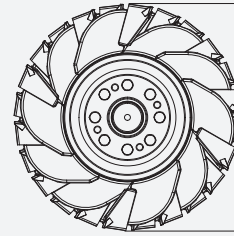
# FORESTRY

## MULCHERS F4







 ŚREDNICA ROTORA  
 ROTOR DIAMETER  
 ROTORDURCHMESSER  
 ДИАМЕТР РОТОРА  
**F4-175** 430 mm  
**F4-200** 430 mm  
**F4-225** 430 mm



Model	HP min/max	mm	Ømm	rpm	N°	N°	kg	1	2	3
<b>F4-175</b>	100-200	1750	250	1000	2x5 XPB	42	1720	2070	1450	1450
<b>F4-200</b>	110-200	2000	250	1000	2x5 XPB	46	1810	2320	1450	1450
<b>F4-225</b>	120-200	2250	250	1000	2x5 XPB	54	1920	2570	1450	1450



-  TYP ZĘBA: DWUPŁYTKOWE WĘGLIKOWE (Z ZAMKIEM)
-  TOOTH TYPE: DOUBLE-PLATE CARBIDE (WITH LOCKED)
-  ZAHNART- CARBID- DOPPELPLATTEN (MIT SCHLOSS BEFESTIGT)
-  ТИП ЗУБА - ДВОЙНОЙ ТВЕРДОСПЛАВНЫЙ (ЗАМЕНИМЫЙ)

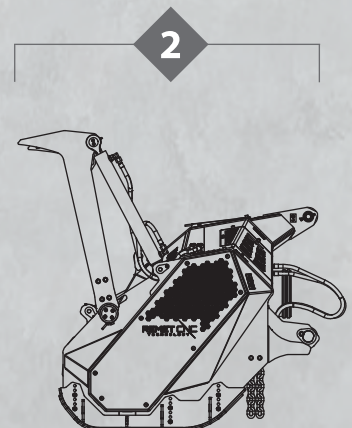
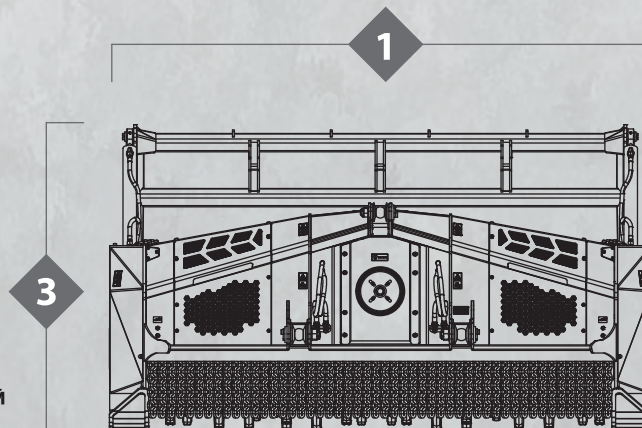







# FORESTRY

## MULCHERS F5

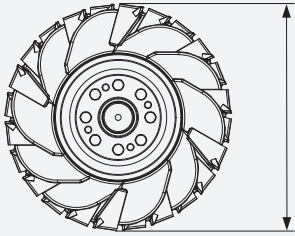
# MULCZERY

## LEŚNE F5







 ŚREDNICA ROTORA  
 ROTOR DIAMETER  
 ROTORDURCHMESSER  
 ДИАМЕТР РОТОРА  
**F5-200** 530 mm  
**F5-225** 530 mm  
**F5-250** 530 mm



Model	HP min/max	mm	Ømm	rpm	N°	N°	kg	1	2	3
<b>F5-200</b>	180-300	2000	350	1000	2x5 XPC	46	2720	2390	1650	1650
<b>F5-225</b>	190-300	2250	350	1000	2x5 XPC	54	2850	2640	1650	1650
<b>F5-250</b>	200-300	2500	350	1000	2x5 XPC	58	3000	2890	1650	1650



 TYP ZĘBA: DWUPŁYTKOWE WĘGLIKOWE  
 (Z ZAMKIEM)  
 TOOTH TYPE: DOUBLE-PLATE CARBIDE  
 (WITH LOCKED)  
 ZAHNART- CARBID- DOPPELPLATTEN  
 (MIT SCHLOSS BEFESTIGT)  
 ТИП ЗУБА - ДВОЙНОЙ ТВЕРДОСПЛАВНЫЙ  
 (ЗАМЕНИМЫЙ)

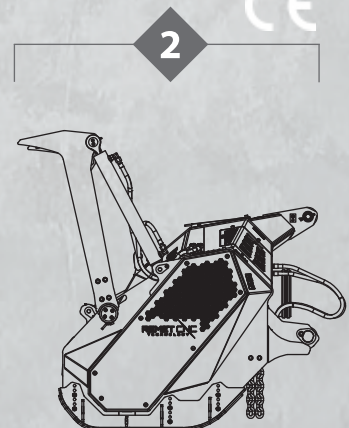
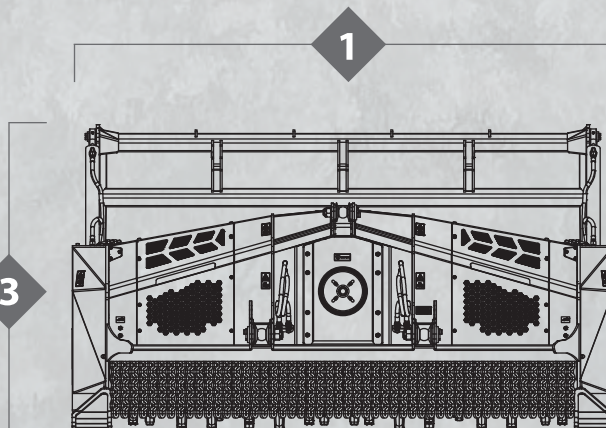







# MULCZERY

## WGŁĘBNE L4

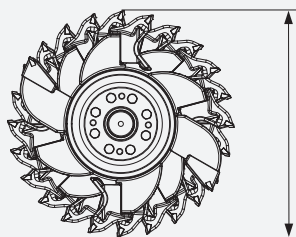
# FORESTRY

## TILLERS L4







 ŚREDNICA ROTORA  
 ROTOR DIAMETER  
 ROTORDURCHMESSER  
 ДИАМЕТР РОТОРА  
**L4-175** 500 mm  
**L4-200** 500 mm  
**L4-225** 500 mm



Model	KM min/max	mm	Ømm	rpm	N°	mm	N°	kg	1	2	3
<b>L4-175</b>	120-250	1750	250	540/1000	2x5 XPB	150	54	2120	2120	1820	1140
<b>L4-200</b>	130-250	2000	250	540/1000	2x5 XPB	150	62	2280	2320	1820	1140
<b>L4-225</b>	140-250	2250	250	540/1000	2x5 XPB	150	70	2440	2570	1820	1140



3

 TYP ZĘBA: JEDNO-PLYTKOWE WĘGLIKOWE WYMIENNE (Z ZAMKIEM)  
 TOOTH TYPE: SINGLE-PLATE INTERCHANGEABLE CARBIDE (WITH LOCKED)  
 ZAHNART: AUSTAUSCHBARE CARBID-EINZELPLATTE (MIT SCHLOSS BEFESTIGT)  
 ТИП ЗУБА - ОДНА ТВЕРДОСПЛАВНАЯ ПЛАСТИНА (ЗАМЕНЯЕМАЯ)

1

2

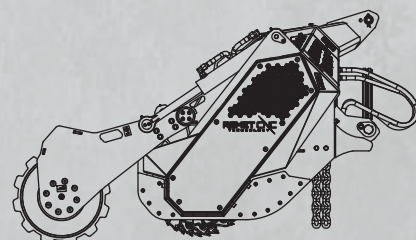
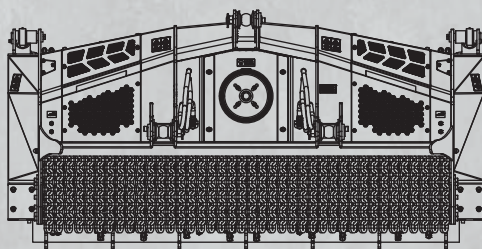







# FORESTRY

## TILLERS L5

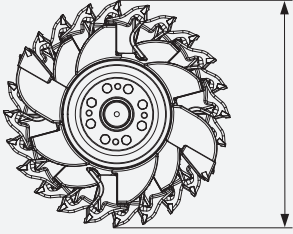
# MULCZERY

## WGŁĘBNE L5







 ŚREDNICA ROTORA  
 ROTOR DIAMETER  
 ROTORDURCHMESSER  
 ДИАМЕТР РОТОРА  
**L5-200** 600 mm  
**L5-225** 600 mm  
**L5-250** 600 mm



Model	KM min/-	mm	Ømm	rpm	N°	mm	N°	kg	1	2	3
<b>L5-200</b>	150-300	2000	400	1000	2x5 XPC	300	62	3260	2400	2180	1380
<b>L5-225</b>	170-300	2250	400	1000	2x5 XPC	300	70	3420	2650	2180	1380
<b>L5-250</b>	190-300	2500	400	1000	2x5 XPC	300	78	3590	2900	2180	1380



 TYP ZĘBA: JEDNO-PŁYTKOWE WĘGLIKOWE WYMIENNE (Z ZAMKIEM)  
 TOOTH TYPE: SINGLE-PLATE INTERCHANGEABLE CARBIDE (WITH LOCKED)  
 ZAHNART- AUSTAUSCHBARE CARBID-EINZELPLATTE (MIT SCHLOSS BEFESTIGT)  
 ТИП ЗУБА - ОДНА ТВЕРДОСПЛАВНАЯ ПЛАСТИНА (ЗАМЕНЯЕМАЯ)

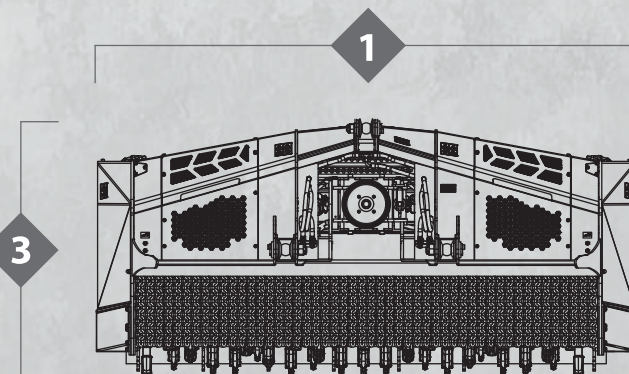







# MULCZERY

## HYDRAULICZNE F4S

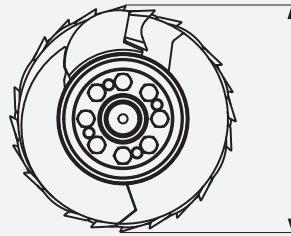
# MULCHERS

## HYDRAULIC F4S



 ŚREDNICA ROTORA  
 ROTOR DIAMETER  
 ROTORDURCHMESSER  
 ДИАМЕТР РОТОРА  
**F4S-160** 440 mm  
**F4S-190** 440 mm  
**F4S-225** 440 mm



OIL FLOW







RECOMMENDED PRESSURE

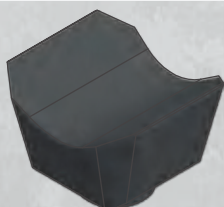

Model	HP min/max	mm	Ømm	l/min	N°	Bar	N°	kg	mm	mm	mm
<b>F4S-160</b>	70-180	1600	250	80-220	1x Poly Chain	200-350	32	1180	1860	1190	1370
<b>F4S-190</b>	70-180	1900	250	80-220	1x Poly Chain	200-350	40	1280	2320	1190	1370
<b>F4S-225</b>	80-180	2250	250	100-220	1x Poly Chain	200-350	48	1450	2570	1190	1370



-  TYP ZĘBA: DWUSTRONNY ZE STALI O PODWYŻSZONEJ WYTRZYMAŁOŚCI (HARTOWANY)
-  TOOTH TYPE: DOUBLE-SIDED STEEL WITH INCREASED STRENGTH (HARDENED)
-  ZAHNART: DOPPELSEITIG STAHL MIT ERHÖHTER BESTÄNDIGKEIT (GEHÄRTET)
-  ТИП ЗУБА - ДВУСТОРОННИЙ СТАЛЬ С ПОВЫШЕННОЙ ПРОЧНОСТЬЮ (ЗАКАЛЁННЫЙ)

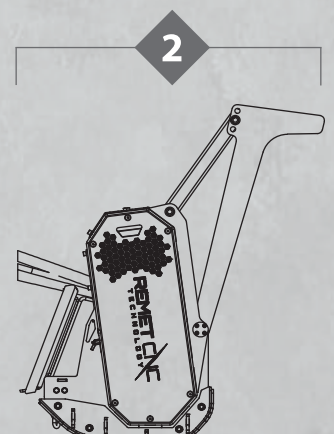
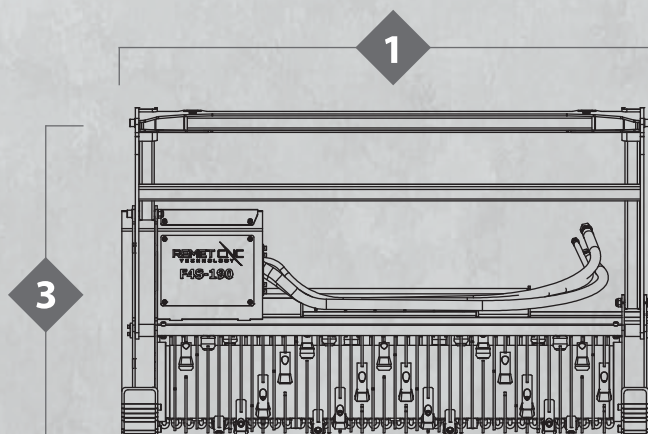







# MULCHERS

## HYDRAULIC F4E

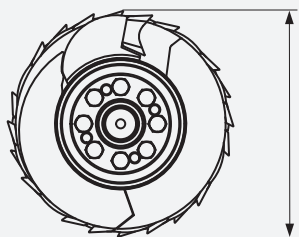
# MULCZERY

## HYDRAULICZNE F4E



 ŚREDNICA ROTORA  
 ROTOR DIAMETER  
 ROTORDURCHMESSER  
 DIAMETR ROTORA  
**F4E-100** 440 mm  
**F4E-125** 440 mm  
**F4E-150** 440 mm



RECOMMENDED WEIGHT



OIL FLOW







RECOMMENDED PRESSURE

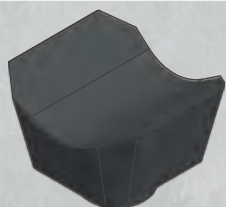

Model	t	mm	Ømm	l/min	N°	Bar	N°	kg	mm	mm	mm
<b>F4S-100</b>	10-20	1000	250	80-220	1x Poly Chain	200-350	20	900	1260	680	1020
<b>F4S-125</b>	12-20	1250	250	80-220	1x Poly Chain	200-350	26	1000	1510	680	1020
<b>F4S-150</b>	12-20	1500	250	100-220	1x Poly Chain	200-350	32	1120	1760	680	1020



-  TYP ZĘBA: DWUSTRONNY ZE STALI O PODWYŻSZONEJ WYTRZYMAŁOŚCI (HARTOWANY)
-  TOOTH TYPE: DOUBLE-SIDED STEEL WITH INCREASED STRENGTH (HARDENED)
-  ZAHNART: DOPPELSEITIG STAHL MIT ERHÖHTER BESTÄNDIGKEIT (GEHÄRTET)
-  ТИП ЗУБА - ДВУСТОРОННИЙ СТАЛЬ С ПОВЫШЕННОЙ ПРОЧНОСТЬЮ (ЗАКАЛЕННЫЙ)

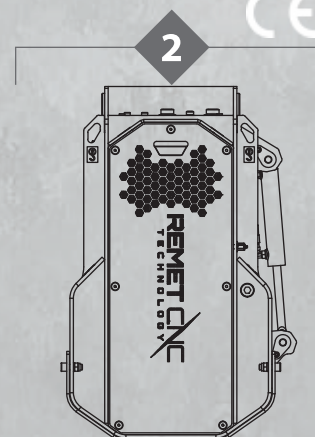
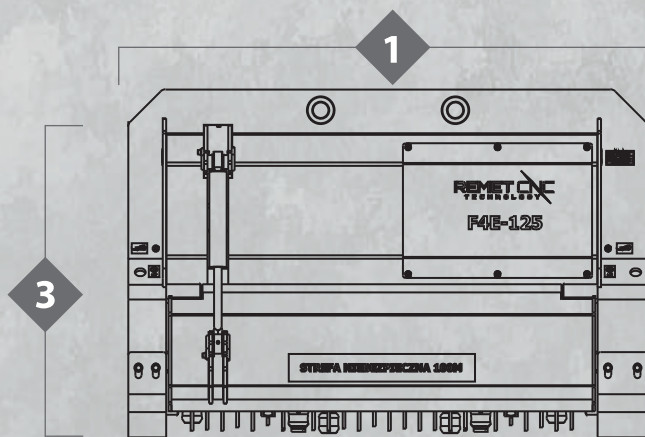



# FASTCUT C-300



RECOMMENDED WEIGHT



OIL FLOW



RECOMMENDED PRESSURE



Model:

t

Ømm

l/min

Bar

kg

mm

mm

mm

**C-300**

8-20

350

50-120

250-350

550

1200

960

660

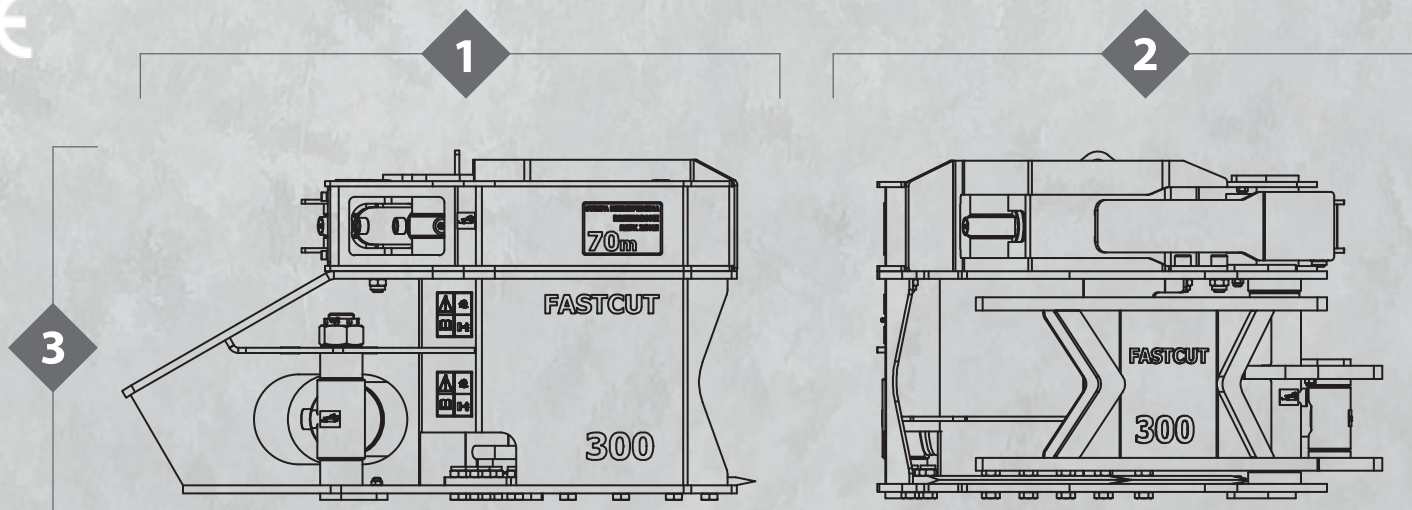





**SPRAWDŹ NASZĄ PEŁNĄ OFERTĘ!  
CHECK OUR FULL OFFER!  
SEHEN SIE BITTE UNSER VOLLES ANGEBOT!  
ПРОВЕРЬТЕ НАШЕ ПОЛНОЕ ПРЕДЛОЖЕНИЕ!**

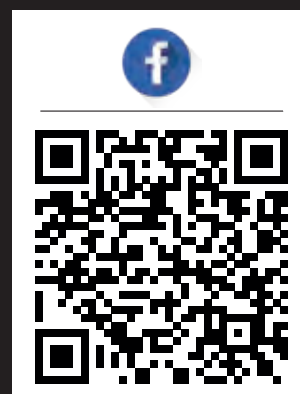
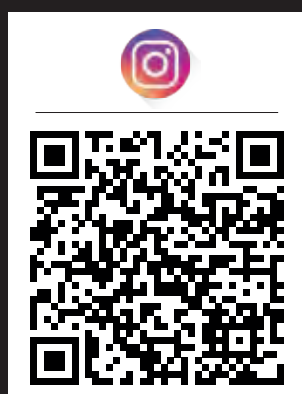
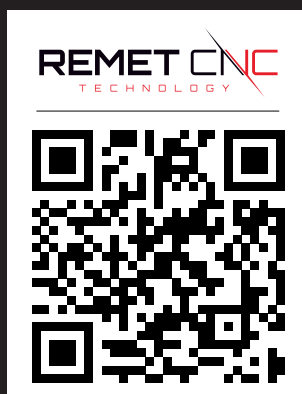

**www.remetcnc.com**



# REMET CNC<sup>®</sup>

TECHNOLOGY



## Informacje\Information\Информация:

PL/ENG

+48 690 917 917

PL/ENG

+48 570 914 914

DE/RUS

+48 733 005 933



[sales@remetcnc.com](mailto:sales@remetcnc.com)

Łowisko 320A, 36-053 Kamień  
woj. podkarpackie

[www.remetcnc.com](http://www.remetcnc.com)  
[www.mulczery.pl](http://www.mulczery.pl)

